

SHORELINE STEEL, INC.

58059 MAIN ~ P.O. BOX 480519 ~ NEW HAVEN, MICHIGAN 48048
586-749-9559 ~ 800-522-9550 ~ FAX- 586-749-6653

MSZ-19 Bent Corners

Corner Details for MSZ-19-312, MSZ-19-340, MSZ-19-350, MSZ-19-375, MSZ-19-406

OUTSIDE-SIMPLE LOCK
UP TO 90° BEND

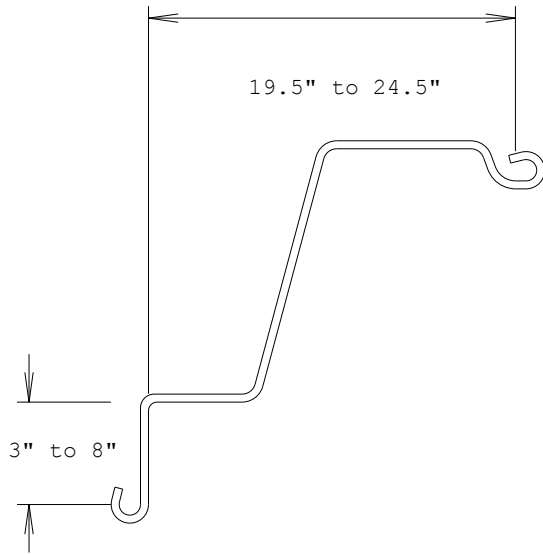

OUTSIDE-COMPLICATED LOCK
UP TO 90° BEND

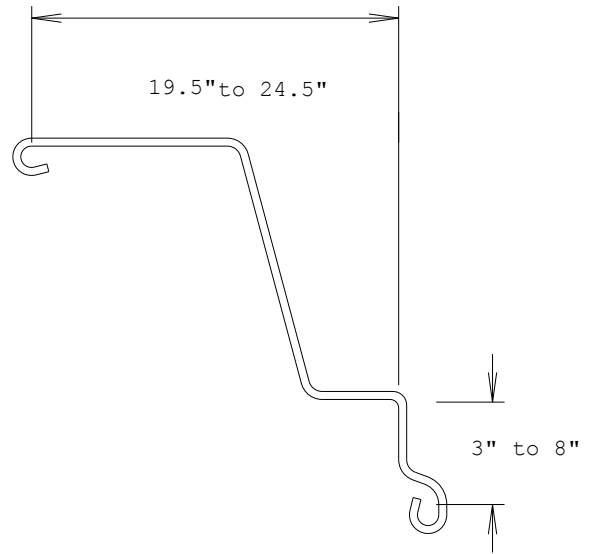

ALL HEAVY PILING SECTIONS CAN BE BENT TO MAKE OUTSIDE CORNERS ON EITHER LOCK LEG. CORNERS CAN BE LOCATED ANYWHERE BETWEEN 3 AND 8 INCHES FROM THE CENTERLINE OF THE LOCK. ALL CORNERS CAN BE BENT TO ANY ANGLE UP TO 90°.